



*Repair Kit No. KK-5044
 (190681)

EGA-503 SPRAY GUN (SPRAY PISTOL)

Important: Before using this equipment, read all safety precautions and instructions. Keep for future use.

DESCRIPTION

The EGA-503 is an external mix, touch-up gun. The gun has a long needle taper making detail work easy. The forefinger trigger gives added control for delicate application. Can be used for touch-up, shading, edging or any type of precision painting. Use as either suction or pressure feed application.

Note

Wetted surfaces are stainless steel and aluminum. Please see Warning on Page 2 regarding explosion hazard.

SPECIFICATIONS

Air Inlet: 1/4" NPS (M)
 Fluid Inlet: 1/4" NPS (M)
 Type Feed: Suction or Pressure
 Wetted Parts: Aluminum & Stainless Steel

P1 = Maximum Air Pressure 100 PSI (7 bar)
 P2 = Maximum Fluid Pressure 50 PSI (3.5 bar)

OPERATION

Prepare and strain material according to the paint manufacturer's instructions. Attach container to fluid inlet and tighten. Adjust incoming air pressure to gun to achieve desired spray results.

Note

To minimize overspray, only use as much pressure as required to atomize material.

PREVENTIVE MAINTENANCE

To clean fluid passages, remove excess material at source, then flush with a suitable solvent.

To clean air cap and fluid tip, brush with a stiff bristle brush. If necessary, use a broom straw or toothpick. Never use a wire or hard instrument. This may scratch or burr holes causing a distorted spray pattern.

Note

Worn parts can cause fluid leakage. When replacing fluid tip or fluid needle, replace both at the same time. Lapped sets are available. Also replace the fluid tip gasket and needle packing at this time.



To prevent damage to the fluid tip or fluid needle, be sure to either 1) push the trigger and hold while tightening the fluid tip or 2) remove the fluid needle adjusting screw to relieve spring pressure.

*Government NSN No. 4940-01-182-6975
 = KK-5044

LUBRICATION

For best results, lubricate the points indicated in Figure 1 daily using Gun Lube SSL-10.

- A. Trigger points
- B. Packings
- C. Adjusting valves
- D. Needle/Air valve springs (occasionally)

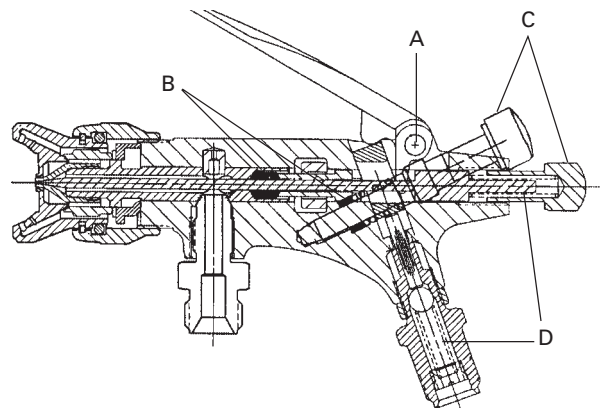

Figure 1

SAFETY PRECAUTIONS

This manual contains information that is important for you to know and understand. This information relates to USER SAFETY and PREVENTING EQUIPMENT PROBLEMS. To help you recognize this information, we use the following symbols. Please pay particular attention to these sections.



Important safety information – a hazard that may cause serious injury or loss of life.





Important information that tells how to prevent damage to equipment, or how to avoid a situation that may cause minor injury.

NOTE

Information that you should pay special attention to.



The following hazards may occur during the normal use of this equipment. Please read the following chart.

HAZARD	CAUSE	SAFEGUARDS
<p>Fire</p> 	<p>Solvents and coatings can be highly flammable or combustible, especially when sprayed.</p>	<ol style="list-style-type: none"> 1. Adequate exhaust must be provided to keep the air free of accumulations of flammable vapors. 2. Smoking must never be allowed in the spray area. 3. Fire extinguishing equipment must be present in the spray area. 4. Static discharges must be prevented. Ground (earth) all conductive objects in the spray area, such as a cleaning solvent bucket, fire extinguisher, etc. 5. When using solvents for cleaning: <ul style="list-style-type: none"> • Those used for equipment flushing must have a flash point equal to or higher than that of the coating. • Those used for general cleaning must have flash points above 100°F (37.8°C).
<p>Inhaling Toxic Substances</p> 	<p>Certain materials may be harmful if inhaled or if there is contact with the skin.</p>	<ol style="list-style-type: none"> 1. Follow the requirements of the Material Safety Data Sheet supplied by your coating manufacturer. 2. Adequate exhaust must be provided to keep the air free of accumulations of toxic materials. 3. Use a mask or respirator whenever there is a chance of inhaling sprayed materials. The mask must be compatible with the material being sprayed and its concentration.
<p>Explosion Hazard – Incompatible Materials</p> 	<p>Halogenated hydrocarbon solvents, for example" methylene chloride and 1, 1, 1, - Trichloroethane, are not chemically compatible with the aluminum that might be used in many system components. The chemical reaction caused by these solvents reacting with aluminum can become</p>	<p>This spray gun (spray pistol) has aluminum passages and cannot be used with these solvents. Aluminum is also widely used in other spray application equipment – such as material pumps, regulators, valves, etc. Check all other equipment items before use. Read the label or data sheet for the material you intend to spray. If in doubt as to whether or not a coating or cleaning material is compatible, contact your material supplier.</p>

SAFETY PRECAUTIONS (Continued)

HAZARD	CAUSE	SAFEGUARDS
General Safety	Improper operation or maintenance of equipment.	Operators should be given adequate training in the safe use and maintenance of the equipment (in accordance with the requirements of NFPA-33, Chapter 15 in U.S.). Users must comply with all local and national codes of practice and insurance company requirements governing ventilation, fire precautions, operation, maintenance and housekeeping (in the U.S., these are OSHA Sections 1910.94 and 1910.107 and NFPA-33).
Solvent Spray 	During cleaning and flushing, solvents can be forcefully expelled from fluid and air passages. Some solvents can cause eye injury.	Wear eye protection.
<p>Misuse:</p> <ul style="list-style-type: none"> • All spray guns (spray pistols) project particles at high velocity and must never be aimed at any part of the body. • Never exceed the recommended safe working pressures for any of the equipment used. • The use of non-recommended or non-original accessories or spare parts may create hazardous conditions. • Before dismantling the equipment for cleaning or maintenance, all pressures, air and fluid, must be isolated and released. <p>The disposal of waste materials must be carried out in an approved manner. Burning may generate toxic fumes. The removal or waste solvents and coating materials should be carried out by an authorized local waste disposal service.</p>		

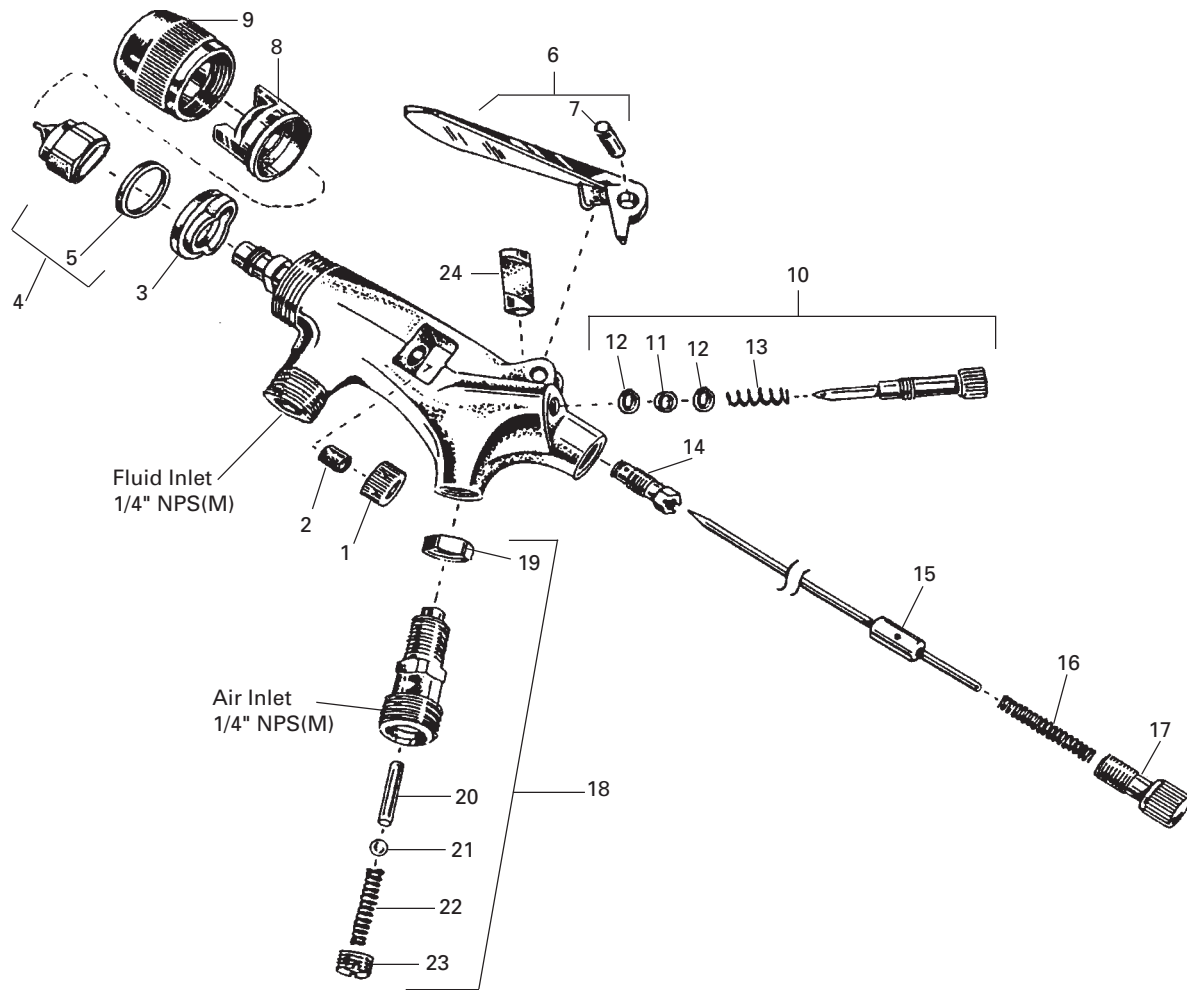





PARTS LIST

Ref. No.	Replacement Part No.	Description	Individual Parts Req.
1	EGA-4	Packing Nut	1
■ 2	38273-136-K5	Fluid Needle Packing (Kit of 5)	1
3	EGA-7	Baffle	1
4	EGA-4000-F	Tip, Needle & Gasket (includes 4, 5, 15)	1
■ 5	EGA-59-K5	Gasket (Kit of 5)	1
6	EGA-443	Trigger and Stud Assy.	1
■ 7	AG-3-1-K5	Trigger Bearing Stud (Kit of 5)	1
8	EGA-40-390	Air Cap	1
9	EGA-11	Retaining Ring	1
10	EGA-454	Fan Adjusting Assembly	1
■ 11	SSG-8205-K10	O-Ring (Kit of 10)	1
■ 12	AG-26-K10	Washer (Kit of 10)	2
■ 13	---	Spring	1
14	EGA-3	Packing Gland	1
15	---	Fluid Needle (included with Item 4)	1
■ 16	AG-7-K5	Needle Spring Kit (Kit of 5)	1
17	AG-16	Fluid Needle Adjusting Screw	1
18	EGA-441	Air Valve Assy.	1
19	AG-46-K3	Lock Nut (Kit of 3)	1
■ 20	EGA-9-K5	Stem (Kit of 5)	1
■ 21	SST-3008-K5	Ball (Kit of 5)	1
■ 22	C-104-K5	Spring (Kit of 5)	1
23	GD-36-K5	Spring Retainer (Kit of 5)	1
■ 24	EGA-5-K6	Air Valve Plunger (Kit of 6)	1

■ A quantity of necessary parts is included in Gun Repair Kit KK-5044. Government NSN No. 4940-01-182-6975 = KK-5044. Suffixes -K3, -K5, etc. designates kits of multiple parts. Example: 38273-136-K5 is a kit of (5) packings.

TROUBLESHOOTING

CONDITION	CAUSE	CORRECTION
Heavy top or bottom pattern 	Horn holes plugged. Obstruction on top or bottom of fluid tip. Cap and/or tip seat dirty.	Clean. Ream with non-metallic point. Clean. Clean.
Heavy right or left side pattern 	Left or right side horn holes plugged. Dirt on left or right side of fluid tip. Remedies for top-heavy, bottom-heavy, right-heavy and left-heavy patterns: 1) Determine if obstruction is on cap or fluid tip. Do this by making a test pattern. Then, rotate cap one-half turn and spray another pattern. If defect is inverted, obstruction is on air cap. Clean air cap as previously instructed. 2) If defect is not inverted, it is on fluid tip. Check for a fine burr on edge of fluid tip. Remove with #600 wet or dry sand paper. 3) Check for dried material just inside opening. Remove by cleaning.	Clean. Ream with non-metallic point. Clean.
Heavy center pattern 	Material flow exceeds air cap's capacity. Atomizing pressure too low. Material too thick.	Thin or lower fluid flow. Increase pressure. Thin to proper consistency.
Split spray pattern 	Fluid adjusting knob turned in too far. Insufficient material flow. Atomization air pressure too high. Too much fan air.	Back out counterclockwise to achieve proper flow. Increase fluid pressure (pressure feed). Reduce air pressure. Turn fan adjust in to reduce.
Jerky or fluttering spray 	Loose or damaged fluid tip/seat.* Material level too low. Container tipped too far. Obstruction in fluid passage. Loose or broken fluid tube or fluid inlet nipple. Dry or loose needle packing nut.	Tighten or replace. Refill. Hold more upright. Clean. Tighten or replace. Lubricate or tighten.
Will not spray	No air pressure at gun. Needle adjusting screw not open enough.	Check air supply and air lines. Open needle adjusting screw.
Excessive overspray (spray mist)	Too much atomization air pressure. Gun too far from work surface. Improper stroking (arching, gun motion too fast).	Reduce pressure. Adjust to proper distance. Move at moderate pace, parallel to work surface.
Dry Spray	Air pressure too high. Gun tip too far from work surface. Gun motion too fast. Gun out of adjustment.	Decrease air pressure. Adjust to proper distance. Slow down. Adjust.
Fluid leaking from packing nut	Packing nut loose. Packing worn or dry.	Tighten, do not bind needle. Replace or lubricate.
Fluid leaking or dripping from front of gun	Foreign matter in tip.* Packing nut too tight. Dry packing. Fluid tip or needle worn or damaged. Needle spring deformed or broken.	Clean. Adjust. Lubricate. Replace tip & needle with lapped set. Replace.
Runs and sags	Too much material flow. Material too thin. Gun tilted on an angle.	Adjust gun or reduce fluid pressure. Mix properly or apply light coats. Hold gun at right angle to work and adapt to proper gun technique.
Thin, sandy coarse finish, drying before it flows out	Gun too far from surface. Too much air pressure. Improper thinner being used.	Check distance. Normally 6-8" (152-203 mm). Reduce air pressure and check spray pattern. Follow paint mfg's mixing instructions.
Thick, dimpled finish "orange peel" Too much material coarsely atomized	Gun too close to surface. Air pressure too low, or too much material. Improper thinner being used. Material not properly mixed. Surface rough, oily, dirty.	Check distance. Normally 6-8" (152-203 mm). Increase air pressure or reduce fluid pressure. Follow paint manufacturer's mixing instructions. Follow paint manufacturer's mixing instructions. Properly clean and prepare.
Excessive fog	Too much, or too fast-drying thinner. Too much atomization air pressure.	Remix properly. Reduce pressure.
Unable to get round spray	Fan adjustment screw not seating right. Air cap retaining ring (nut) loose.	Clean or replace. Tighten.

* Most common problem.

ACCESSORIES

P-H-5516 AIR ADJUSTING VALVE



Enables user to control and reduce air usage at the gun. Ideal for low pressure spraying.

42884-214-K5 3/8" 42884-215-K10 5/8" CLEANING BRUSHES



These brushes are helpful in cleaning threads and recesses of gun body. Available in U.S. only.

WR-103 WRENCH



Contains all necessary tip, hose and nut sizes used on or with gun. Available in U.S. only.

TGS-503 Cup



8 ounce (240 ml) polyethylene suction cup.

GUN LUBE, SSL-10-K12 2 oz. (60 ml) bottle



Compatible with all paint materials: contains no silicone or petroleum distillates to contaminate paint.

HAV-500 or HAV-501 Air Adjusting Valve (HAV-501 shown)



HAV-500 does not have pressure gauge. Use to control air usage at gun

HARG-510 Air Regulator

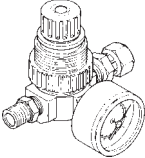

Use to maintain nearly constant outlet pressure despite changes in inlet pressure and downstream flow.

Millennium 3000 Twin Cartridge Paint Spray Respirator



NIOSH-Certified, for respiratory protection in atmospheres not immediately dangerous to life.

192212 Professional Spray Gun Cleaning Kit (ITW Automotive Refinish)



Contains six precision tools designed to effectively clean all DeVilbiss, Finishline and other brand spray guns.

192218 Scrubs® Hand Cleaner Towels (ITW Automotive Refinish)

29-3100 Scrubs® Hand Cleaner Towels (ITW Industrial Finishing)



Scrubs® are a pre-moistened hand cleaner towel for painters. No water is needed.

EGA-439-395 Air Cap w/Ring

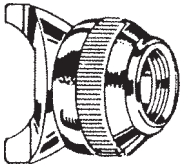

Optional air cap provides wider spray patterns (up to 6"). Use with EGA-4000-E fluid tip and needle set (.070").

WARRANTY

This product is covered by DeVilbiss' 1 Year Limited Warranty.

DeVilbiss Worldwide Sales and Service Listing: www.devilbiss.com

ITW Industrial Finishing

DeVilbiss has authorized distributors throughout the world. For technical assistance or the distributor nearest you, see listing below.

U.S./Canada Technical Service Office:

195 Internationale Blvd., Glendale Heights, IL 60139
Toll-Free Telephone: 1-888-992-4657 (U.S.A. and Canada only)
Toll-Free Fax: 1-800-368-8401

DeVilbiss Automotive Refinishing

DeVilbiss has authorized distributors throughout the world. For equipment, parts and service, check the Yellow Pages under "Automotive Body Shop Equipment and Supplies." For technical assistance, see listing below.

U.S./Canada Customer Service Office:

1724 Indian Wood Circle, Suite J-K, Maumee, OH 43537
Toll-Free Telephone: 1-800-445-3988 (U.S.A. and Canada only)
Toll-Free Fax: 1-800-445-6643

